

# A NEW RF SYSTEM FOR THE DEBUNCHER AT THE KEK 40-MEV PROTON LINAC

Z. Igarashi, E. Takasaki, T. Takenaka and K. Nanmo  
 High Energy Accelerator Research Organization, KEK  
 1-1 Oho Tsukuba-shi Ibaraki-ken, 305-0801, Japan

## Abstract

The rf system for the debuncher at the KEK 40-MeV proton linac was renewed to an all solid-state one during the long shut down last summer. Since the amplifier of this system, containing one hundred and eight power transistors on its' final stage, can deliver a stable 20kW at 201MHz, the momentum spread of the linac beam can be decreased to less than 1%. This new rf system for the debuncher and its operational results are described.

## 1 INTRODUCTION

Although the debuncher cavity was replaced by the reentrant type with a single gap when the linac was upgraded from 20MeV to 40MeV in 1980 [1], the vacuum tube amplifier had been used since the linac construction as the rf source for the debuncher. This vacuum-tube amplifier had caused problems due to the short-lived vacuum-tube; furthermore production of the vacuum-tube for the final stage of the amplifier was discontinued. It was thus decided to replace it by a new amplifier which is the same as those of the predrivers of the rf systems for the DTLs [2] and the prebuncher [3].

## 2 NEW RF SYSTEM

The new rf system consists of nine transistor amplifier modules, rf power divider/combiners, dc power supplies

and a control system. Figs. 1 and 2 show this system and a block diagram [4].

The transistor amplifier module, which was originally developed for cw operation of a TV transmitter, was refined for pulse operation, and can deliver more than 2kW.

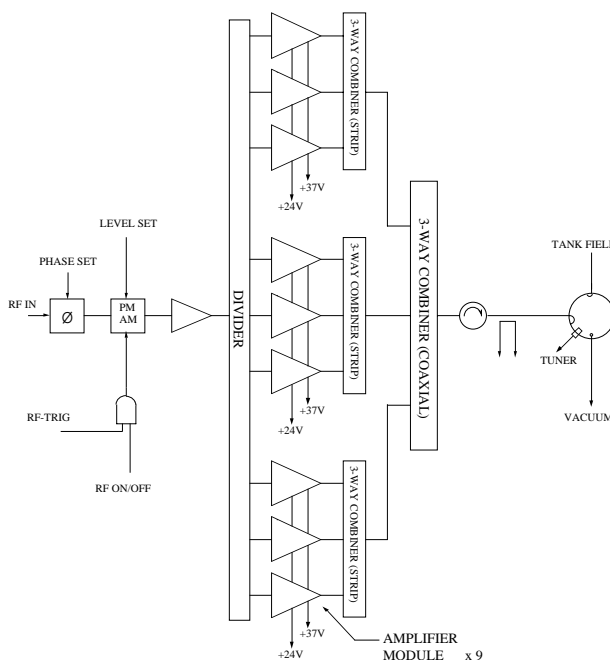

Figure 2: Block diagram of the new rf system.



Figure 1: New rf system.

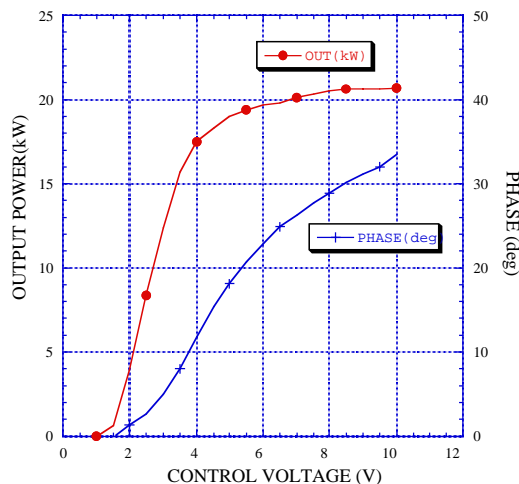

Figure 3: Output characteristics of the new rf system.

The rf power transistor used in the final stage of the module is the 2SC3286-M, which adopts the so-called Gemini package, in which two transistor chips are mounted for push-pull operation, and generates about 200W.

The outputs of the nine modules are first summed up by three stripline 3-way combiners, and then by a coaxial 3-way combiner.

The output power and phase of the system are shown in Fig. 3. Control of this new rf source is achieved using a programmable logic controller [5]. The screen for control and status display of the system is shown in Fig. 4.

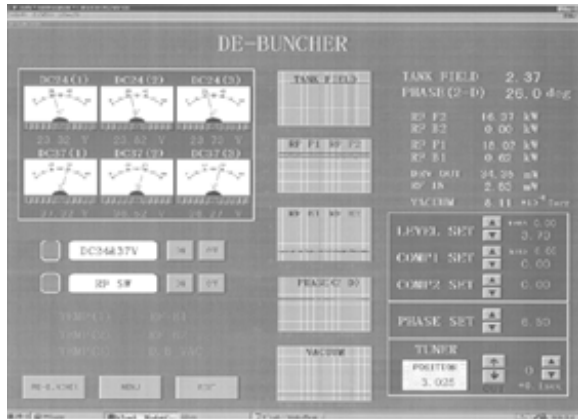

Figure 4: The screen for control and status display.

### 3 OPERATIONAL RESULTS

The field waveform of the debuncher and the beam-energy variations by the debuncher phase are shown in Figs. 5 and 6.

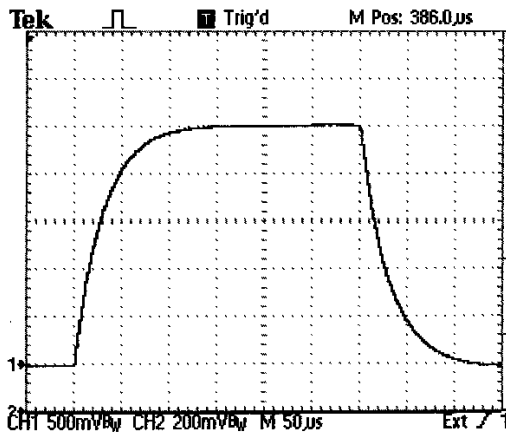

Figure 5: Waveform of the tank field.

The energy variations shown in Fig. 6, which were measured by the velocity monitor [6], are in good agreement with the calculated values. The upper part of the momentum-analyzer output in Fig. 7 is for the debuncher being off, and the lower one is for the input power being 19kW.

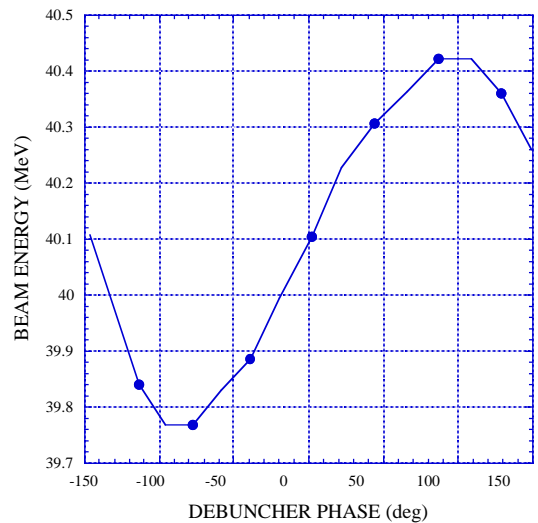

Figure 6: Beam energy versus debuncher phase.

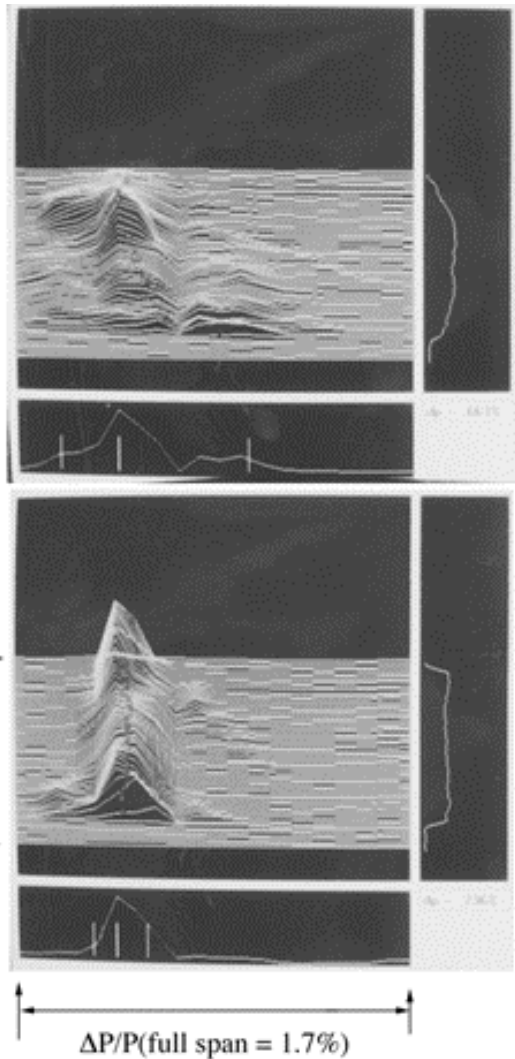

Figure 7: Momentum-analyzer outputs.

Upper : debuncher off  
Lower : Pin=19kW

The momentum spread of the linac beam ( $\Delta P/P$ ) versus the debuncher field and the bunch length of the 500MeV booster synchrotron before extraction versus  $\Delta P/P$  varied by the debuncher are given in Figs. 8 and 9. These results show that the debuncher is effective to decrease  $\Delta P/P$  of the linac and the booster synchrotron.

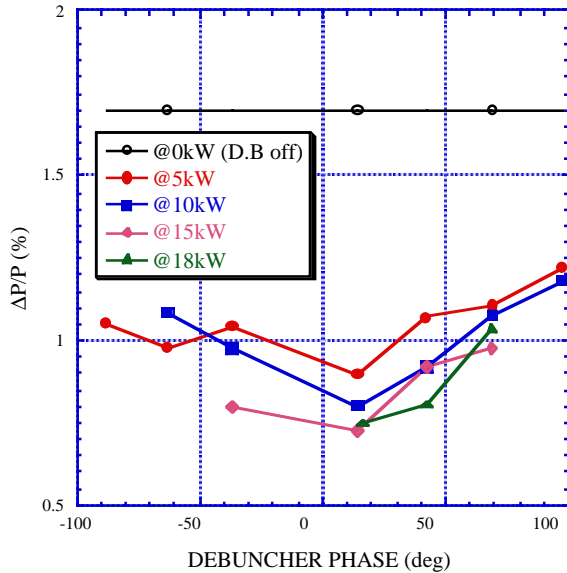

Figure 8:  $\Delta P/P$  versus debuncher field .

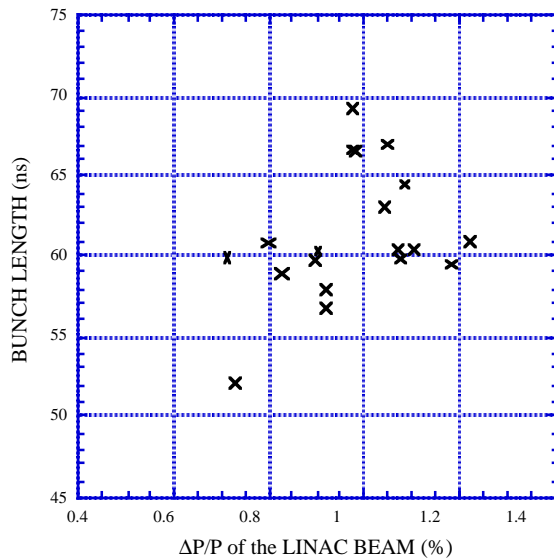

Figure 9: Booster bunch length versus linac  $\Delta P/P$  .

## 4 CONCLUSION

The momentum spread of the linac beam has been decreased from 1.4% to 0.7% by the renewing of the rf system for the debuncher. Throughout the operations for about one year, it was proved that the new system is very stable and reliable without any problems; furthermore, the debuncher is much more useful for the tuning the linac and the booster synchrotron, consequently all of the 12-GeV proton synchrotron, than before.

## REFERENCE

- [1] T.Kato et.al., "Debuncher for the 40MeV Proton Linac", Proceedings of the 11th Linac Meeting in Japan, 111-113 (1986).
- [2] Z.Igarashi et al., "10kW All Solid State RF Power Amplifier ", Proceedings of the 13th Linac Meeting in Japan, 34-36 (1988).
- [3] Z.Igarashi et al., "Renewal of the RF Source for the Prebuncher at KEK Proton Linac", Proceedings of the 21st Linac Meeting in Japan, 195-197 (1996).
- [4] Z.Igarashi et al., "Renewal of the RF Source for the Prebuncher at KEK Proton Linac", Proceedings of the 22nd Linac Meeting in Japan, 131-133(1997).
- [5] E.Kadokura et.al., "Improvement of PS Linac Control System", Proceedings of the 20th Linac Meeting in Japan, 215-217 (1995).
- [6] Z.Igarashi et.al., "Velocity Monitor for the KEK 40MeV Proton Linac", Proceedings of LINAC92, Ottawa, August 23-28, 1992, 112-114 (1992).